

EDU  
**velleman-kit** 

# EDUCATIONAL PC OSCILLOSCOPE KIT

FR KIT D'OSCILLOSCOPE ÉDUCATIF POUR PC  
NL EDUCATIEVE OSCILLOSCOOPKIT VOOR PC  
DE OSZILLOSKOP-LERNPAKET FÜR PC  
ES KIT EDUCATIVO CON OSCILOSCOPIO PARA PC



[WWW.VELLEMANPROJECTS.EU](http://WWW.VELLEMANPROJECTS.EU)

**EDU09**



DISCOVER THE  
WORLD OF ELECTRONICS





**Velleman N.V.**

**Legen Heirweg 33**

**9890 Gavere**

**(België)**

Search product

## Navigation

- ▶ Main page
- ▶ Products
- ▶ Sales outlets
- ▶ Support
- ▶ Publications
- ▶ Jobs
- ▶ About us

## News

## NEW FX193 LED CUBE

CubeXimator software available for download here!!!

Posted on 04-06-12

[Read more...](#)

**velleman**  
projects

Velleman Projects  
All about the Velleman own  
developments: Kits, Modules,  
Instruments and Home Automation

United Kingdom -  
English (UK)  
[Change](#)

## Velleman Projects Newsletter

Are you an electronics enthusiastic or simply interested in our kits, mini-kits, modules and instruments?

Subscribe to our newsletter and receive every month the latest news, new products & updates on Velleman Projects.

You will receive an e-mail. Click on the link in that e-mail to confirm your subscription.

Email:



Do you want to unsubscribe? Click on the "unsubscribe" link in the footer of the last received newsletter from Velleman Projects.

- velleman.eu
- hcgpower.eu
- panel.eu
- vellemanprojects.com  
kits, modules, instruments
- vellbus.eu
- forum.velleman.eu

Advertisements

DAC1  
DAC2  
AT

K8855(W) / V8150(W)  
Android Application



Subscribing our newsletter?, visit [www.vellemanprojects.eu](http://www.vellemanprojects.eu)

**velleman**  
projects

INSTRUMENTS  
velleman  
KITS kit  
www.velleman.eu

Support Forum (EN/FR)  
Velleman Projects

[Login](#) [Register](#)

View unanswered posts | View active topics

[Board index](#) All times are UTC

	Forum	Topics	Posts	Last post
<b>General</b>				
8	Forum rules, suggestions, do forum, Read FAQ & link an external file Moderation: Velleman Support	2	2	Wed Dec 05, 2012 12:04 pm <a href="#">v81a2.7</a>
2	Forum Administration Velleman & Home Forum Discussions Moderation: Velleman Support	3	4	Thu Nov 03, 2011 1:22 pm <a href="#">v81a2.7</a>
<b>vellbus</b>				
	Vellbus Home Automation Internal section for our new vellbus home automation system (closed) Moderation: Velleman Support	404	2072	Thu Sep 13, 2012 5:13 pm <a href="#">v81a2.7</a>
<b>Misc (Soldering projects - Projects is cooler)</b>				
2	Solder For other topics, general tips and tricks, new ideas Moderation: Velleman Support	133	426	Wed Sep 05, 2012 3:37 pm <a href="#">v81a2.7</a>
2	Audio kits/projects All audio related projects, amplifiers, voice amplifiers Moderation: Velleman Support	863	2493	Fri Sep 14, 2012 9:32 pm <a href="#">v81a2.7</a>
2	PC/Solder Projects For projects that are connected to the PC via interface cards Moderation: Velleman Support	1438	4948	Thu Sep 13, 2012 9:04 pm <a href="#">v81a2.7</a>
2	Microcontroller Programmer / Experimenting Projects Here you can discuss PIC programming, example soft... Moderation: Velleman Support	463	1748	Thu Sep 13, 2012 4:27 pm <a href="#">v81a2.7</a>
2	Theory and Details All about our link related projects from regular clocks to programmable timers Moderation: Velleman Support	263	896	Fri Sep 07, 2012 6:46 pm <a href="#">v81a2.7</a>
2	Router Projects Inventor/related articles, from light drivers to remote control Moderation: Velleman Support	636	2283	Fri Sep 14, 2012 11:00 pm <a href="#">v81a2.7</a>

**View  
Forum**



Participate our Velleman Projects Forum



## Oscilloscope

- bandwidth: DC to 200 kHz  $\pm$  3 dB
- input impedance: 100 kohm / 20 pF
- maximum input voltage: 30 V (AC + DC)
- time base: 10  $\mu$ s to 500 ms per division
- input range: 100 mV to 5 V/division
- input sensitivity: 3 mV display resolution
- readouts: True RMS, dBV, dBm, p to p, Duty cycle, Frequency...
- record length: 1k samples
- sampling frequency: 62.5 Hz to 1.5 MHz
- sample history function
- auto set-up function
- pre-trigger function : on 0.1 ms/div .. 500 ms/div ranges
- persistence options: Colour graded, Variable and Infinite

## Transient Recorder

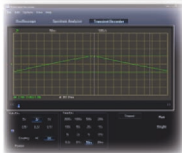

- timescale: 20 ms/div to 2000 s/div
- max. recording time: 9.4 h/screen
- automatic storage of data
- record and display of screens
- automatic recording for more than 1 year
- max. number of samples: 100/s
- min. number of samples: 1 sample/20 s

## Spectrum Analyzer

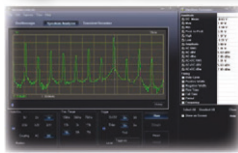

- frequency range: 0 .. 150 Hz to 75 kHz
- operating principle: FFT (Fast Fourier Transform)
- FFT resolution: 512 lines

## General information

- markers for: amplitude/voltage & frequency/time
- expert or basic mode selection in software
- input coupling: DC and AC
- 8 bit resolution
- storage of display and data
- power supply through USB: +/- 200 mA
- uses Microsoft® human interface device (HID) driver, no external driver required
- dimensions: 94 x 94 mm / 3.7 x 3.7"

## Min. system requirements

- IBM compatible PC
- Windows® XP, Vista, 7, 8 \*
- SVGA display card (min. 1024 x 768)
- mouse
- free USB port 1.1 or 2.0



For software, visit [www.vellemanprojects.eu](http://www.vellemanprojects.eu)

\* Windows™ is a registered trademarks of Microsoft Corporation

## assembly hints

### 1. Assembly (Skipping this can lead to troubles !)

Ok, so we have your attention. These hints will help you to make this project successful. Read them carefully.



#### 1.1 Make sure you have the right tools:

- A good quality soldering iron (25-40W) with a small tip.
- Wipe it often on a wet sponge or cloth, to keep it clean; then apply solder to the tip, to give it a wet look. This is called 'thinning' and will protect the tip, and enables you to make good connections. When solder rolls off the tip, it needs cleaning.
- Thin raisin-core solder. Do not use any flux or grease.
- A diagonal cutter to trim excess wires. To avoid injury when cutting excess leads, hold the lead so they cannot fly towards the eyes.
- Needle nose pliers, for bending leads, or to hold components in place.
- Small blade and Phillips screwdrivers. A basic range is fine.



☞ For some projects, a basic multi-meter is required, or might be handy



#### 1.2 Assembly Hints :

- Make sure the skill level matches your experience, to avoid disappointments.
- Follow the instructions carefully. Read and understand the entire step before you perform each operation.
- Perform the assembly in the correct order as stated in this manual
- Position all parts on the PCB (Printed Circuit Board) as shown on the drawings.
- Values on the circuit diagram are subject to changes, the values in this assembly guide are correct\*
- Use the check-boxes to mark your progress.
- Please read the included information on safety and customer service

\* Typographical inaccuracies excluded. Always look for possible last minute manual updates, indicated as 'NOTE' on a separate leaflet.

#### 1.3 Soldering Hints :

1. Mount the component against the PCB surface and carefully solder the leads



2. Make sure the solder joints are cone-shaped and shiny



3. Trim excess leads as close as possible to the solder joint



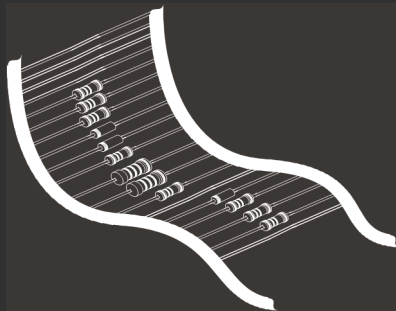

REMOVE THEM FROM THE TAPE ONE AT A TIME !

Included in  
this kit

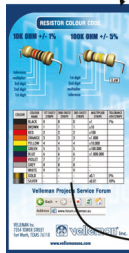

## 2. RESISTOR

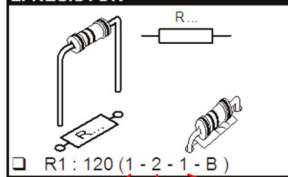

COLOUR	COLOUR NAME	1ST DIGIT/ STRIPE	2ND DIGIT/ STRIPE	3RD DIGIT/ STRIPE	MULTIPLIER STRIPE	TOLE 4TH!
BLACK	BLACK	0	0	0	x1	1%
BROWN	BROWN	1	1	1	x10	
RED	RED	2	2	2	x100	
ORANGE	ORANGE	3	3	3	x1.000	
YELLOW	YELLOW	4	4	4	x10.000	
GREEN	GREEN	5	5	5	x100.000	
BLUE	BLUE	6	6	6	x1.000.000	

**DO NOT BLINDLY FOLLOW THE ORDER OF THE COMPONENTS ON THE TAPE. ALWAYS CHECK THEIR VALUE WITH THE PARTS LIST!**

## I. CONSTRUCTION

### 1 Ceramic Capacitors

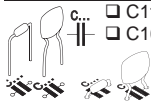

- C11...C13 : 100nF (104)
- C16...C19 : 100nF (104)

### 2 Diodes

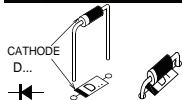

- D1 : BAT85
- D2 : BAT85
- D3 : BAT85
- D4 : BAT85
- D5 : BAT85
- D6 : BAT85
- D7 : BAT85

Watch the polarity!

### 3 Zenerdiode

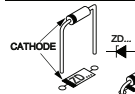

Watch the polarity!

- ZD1 : 5V1

### 4 Choke

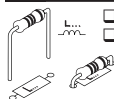

- L1 : 100μH (1 - 0 - 1 - B)
- L2 : 100μH (1 - 0 - 1 - B)

### 5 IC socket

Watch the position of the notch!

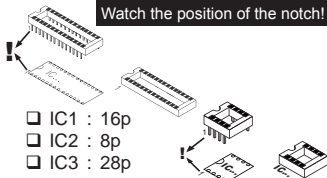

- IC1 : 16p
- IC2 : 8p
- IC3 : 28p

### 6 Trimmer

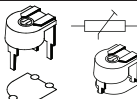

- RV1 : 4K7

### 7 Ceramic Capacitors

- C1 : 2,2pF (2.2)
- C2 : 6,8pF (6.8)
- C3 : 10pF (10)
- C4 : 15pF (15)
- C5 : 27pF (27)
- C6 : 27pF (27)
- C7 : 47pF (47)
- C8 : 100pF (101)
- C9 : 470pF (471)
- C10 : 680pF (681)
- C14 : 1μF (105)
- C15 : 1μF (105)
- C20 : 1μF (105)
- C21 : 1μF (105)
- C22 : 1μF (105)
- C23 : 1μF (105)
- C24 : 1μF (105)

### 8 Vertical resistors

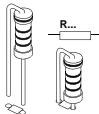

- R1 : 2,2Ω (2 - 2 - B - B)
- R2 : 2,2Ω (2 - 2 - B - B)
- R3 : 100Ω (1 - 0 - 1 - B)
- R4 : 100Ω (1 - 0 - 1 - B)
- R5 : 680Ω (6 - 8 - 0 - 0 - 1)\*
- R6 : 680Ω (6 - 8 - 0 - 0 - 1)\*
- R7 : 680Ω (6 - 8 - 0 - 0 - 1)\*
- R8 : 1KΩ (1 - 0 - 0 - 1 - 1)\*
- R9 : 1KΩ (1 - 0 - 0 - 1 - 1)\*
- R10 : 1KΩ (1 - 0 - 0 - 1 - 1)\*
- R11 : 1KΩ (1 - 0 - 0 - 1 - 1)\*
- R12 : 1KΩ (1 - 0 - 0 - 1 - 1)\*
- R13 : 1KΩ (1 - 0 - 0 - 1 - 1)\*
- R14 : 1K1 (1 - 1 - 0 - 1 - 1)\*
- R15 : 1K5 (1 - 5 - 2 - B)
- R16 : 1K5 (1 - 5 - 2 - B)
- R17 : 2K2 (2 - 2 - 2 - B)
- R18 : 2K7 (2 - 7 - 2 - B)
- R19 : 5K1 (5 - 1 - 0 - 1 - 1)\*
- R20 : 7K5 (7 - 5 - 0 - 1 - 1)\*
- R21 : 10KΩ (1 - 0 - 0 - 2 - 1)\*
- R22 : 10KΩ (1 - 0 - 0 - 2 - 1)\*

\* metallfilm resistor !

- R23 : 11K $\Omega$  (1 - 1 - 0 - 2 - 1)\*
- R24 : 15K $\Omega$  (1 - 5 - 0 - 2 - 1)\*
- R25 : 20K $\Omega$  (2 - 0 - 0 - 2 - 1)\*
- R26 : 20K $\Omega$  (2 - 0 - 0 - 2 - 1)\*
- R27 : 20K $\Omega$  (2 - 0 - 0 - 2 - 1)\*
- R28 : 75K $\Omega$  (7 - 5 - 0 - 2 - 1)\*

## 9 Transistors

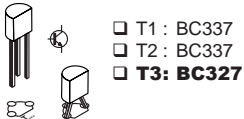

- T1 : BC337
- T2 : BC337
- T3: **BC327**

## 10 Voltage regulator

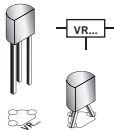

- VR1 : LM317LZ

## 11 Relay switch

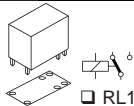

- RL1: TSC-106D3H or eq.

## 12 USB connector

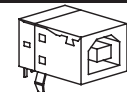

- SK3

## 13 Electrolytic capacitors

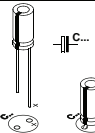

Watch the polarity!

- C25 : 10 $\mu$ F
- C26 : 10 $\mu$ F
- C27 : 10 $\mu$ F
- C28 : 10 $\mu$ F
- C29 : 10 $\mu$ F
- C30 : 100 $\mu$ F
- C31 : 100 $\mu$ F

## 14 Quartz crystal

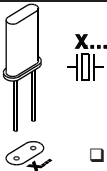

- X1 : 4MHz

## 15 IC's

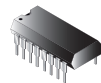

Watch the position of the notch!



- IC1 : CD74HCT4052E



- IC2 : TLV272IP



- IC3 : VKEDU09  
(programmed PIC18F24J501-ISP)



## 16 LED

**STEP 1:** Mount the LED.  
Do not solder yet.

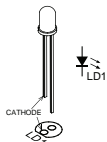
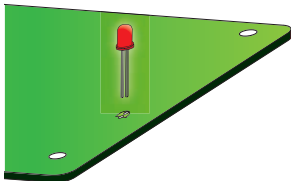

□ LD1 : red

**STEP 2:** Assemble the unit but do not yet tighten the bolts. Position the LED so that it stays just below the cover plate.

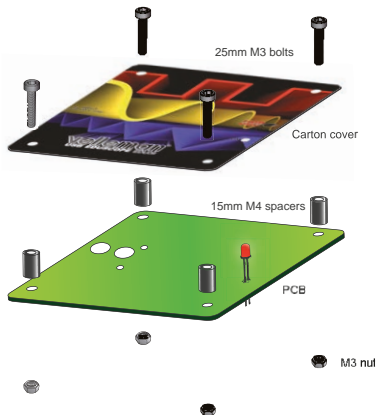

**STEP 3:** Turn the unit 180°

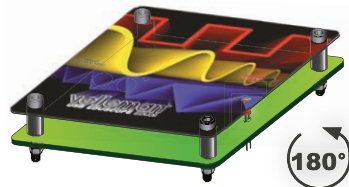

**STEP 4:** Solder one lead and check the position. If OK, solder the second connection.



**STEP 5:** Disassemble the unit.

## 17 Mounting the test leads

**STEP 1:** Cut off the banana plug from the test leads.

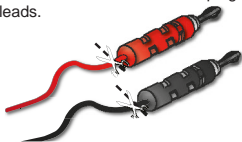

**STEP 2:** Strip both cables and twist the wire ends of each cable.

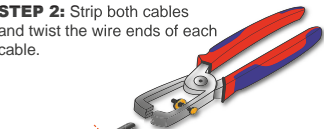

**STEP 3:** Solder the wires.



**STEP 4:** Mount both cables as shown in the drawing.

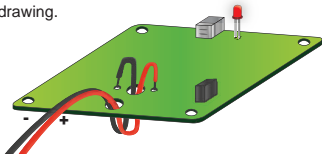

*Tip:* Start with one cable and then do the other.

**STEP 5:** Solder the cables on the PCB.

## II. SOFTWARE INSTALLATION

**Step 1:** Download the EDU09 software on our website: [www.vellemanprojects.eu](http://www.vellemanprojects.eu)

**Step 2:** open the file en select the software.

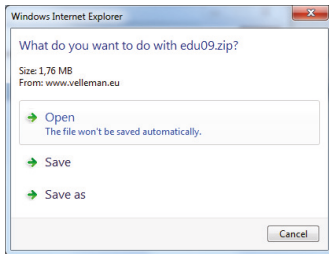

**Step 3:** Select "next" to begin the installation procedure.



**Step 4:** Accept the license agreement

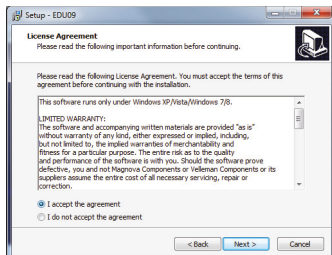

**Step 5:** Select the destination on your PC

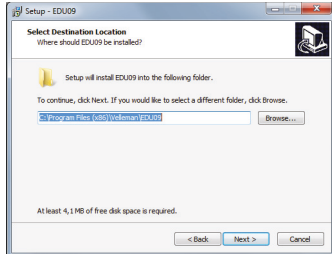

**Step 6:** Select the start menu folder

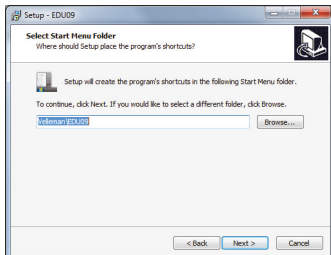

**Step 7:** Select additional tasks you would like to be performed.

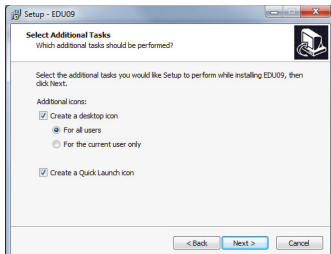

**Step 8:** Select "Install" for installing the software.

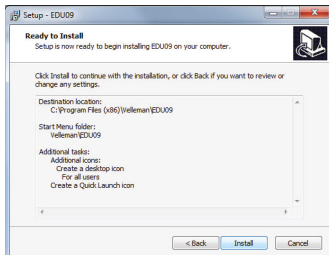

**Step 9:** Click "finish" to exit setup

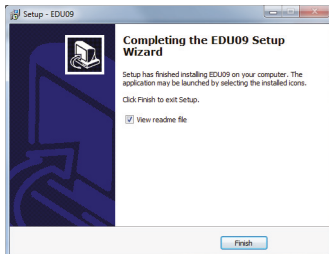

**Step 10:** Connect the unit with the pc.



### III. CALIBRATION

There is no external driver necessary, the EDU09 uses the internal Microsoft Windows HID driver, these will be loaded automatically.

- Set RV1 to the middle position.
- Connect the EDU09 oscilloscope to the USB slot of the PC. The red LED should light.
- Run the installed software EDU09.EXE
- If it is connected for the first time, the calibration procedure will start automatically.
- If it does not start automatically: In the Options menu select "Calibrate" and then click OK to start the calibration. Wait until calibration is successful.

**Advanced calibration:** Fine tuning of the input amplifier circuit (requires a 1.5V battery)

This calibration is not really necessary, you must only do this, if you want a higher precision of your measurements

- In the 'Options'-menu select "Expert Settings".
- In the 'View'-menu select "Waveform Parameters...".
- In the 'Waveform Parameters'-window select the check box "DC Mean".

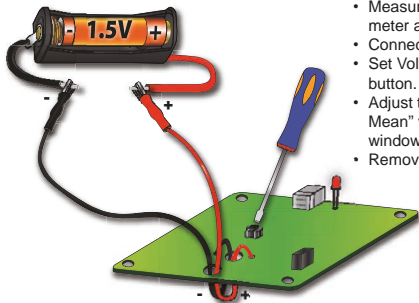

- Measure the output of the battery with a multimeter and remember it.
- Connect the battery to the oscilloscope's input.
- Set Volts/Div. to "0.5V" and click the "Run" button.
- Adjust trimmer RV1 until the displayed "DC Mean" value in the 'Waveform Parameters'-window corresponds with the measured value.
- Remove battery.

### IV. ASSEMBLY

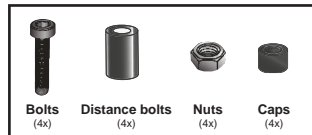

Mount the cover.

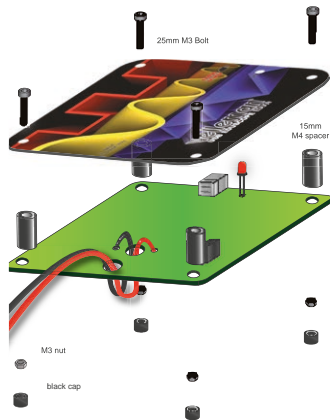

Your scope is now ready for use.

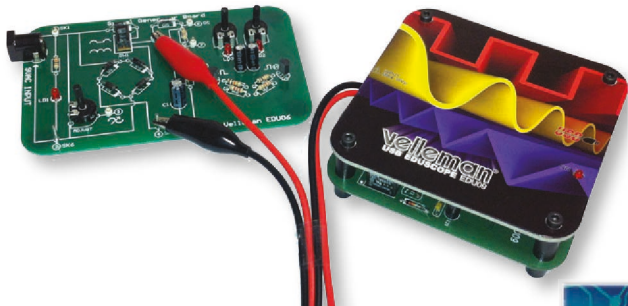

Make sure to check out our EDU6 Oscilloscope tutor kit. It features lots of information and a number of experiments to familiarise yourself with the basics of an oscilloscope.

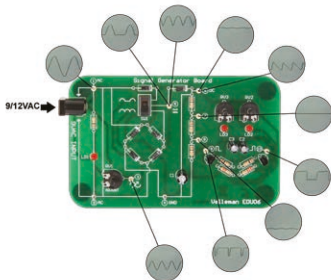

LEARN HOW TO GET THE MOST OUT OF YOUR DIGITAL OSCILLOSCOPE.

EDU06 Oscilloscope Tutor kit

**12 Rectified AC, dual phase**

**Experiment 5: Rectified AC, dual phase**

Connection layout:



Connection laboratory:  
DAD only: 4  
Probe to: 5

Purpose:  
The purpose of this experiment is to show what dual phase rectified AC looks like on a scope screen and to show the difference with single phase rectified AC.

Goal:

1. Turn on the MPT118 (read that!) Pocket Scope and hold it near to work network.
2. Turn the probe switch to the '12' to 'V'.

Select Amplitude and Autoscale:

As the switch is set to single phase rectification  the display will show the same trace as with experiment 4.



Now check what happens when you flip the switch from single phase to dual phase modification. Flip the switch back and forward. It clearly sees the difference between both settings.

**NOTES:**

# OSCILLOSCOPE TERMINOLOGY

1. **Volts/div:** Determines how many volts the signal at the input must swing for the trace to move one division.
2. **Time/div:** Determines the time the trace needs to scan from the the left hand side to the right hand side of a division.
3. **Division:** Imaginary or visible grid on the oscilloscope screen. It helps estimating signal amplitude and period.
4. **Period (T):** Duration of one cycle of the AC waveform (=  $1/f$ )

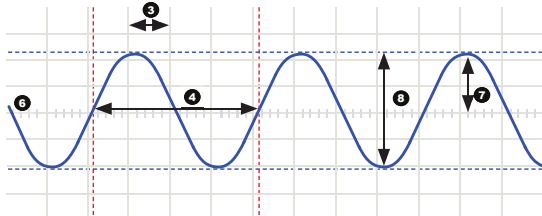

5. **Frequency (f):** The number cycles of the AC waveform per sec.

6. **Trace:** 'line' that is drawn on the screen, which represents the signal at the input.

7. **Amplitude:** How far does the signal 'swing' in a direction. Expressed in mV or V. For repetitive signals:  $V_{peak}$ .

8. **Peak-to-peak:** Difference between most positive and most negative swing of the signal.  $2 \times V_{peak}$  for sinusoidal signals.

**AC coupling:** The oscilloscope only displays the AC component of a signal, any DC level is ignored.

**Analog:** Analog scopes use the incoming signal to deflect an electron beam, which scans from left to right on the screen. The electron beam leaves an image on the screen which represents the signal you've applied. Analog signals are continuously variable. See also 'Digital'.

**'Auto-setup' mode:** The oscilloscope automatically selects a setting for Volts/div and Time/div in such a way that one or more periods of signal are displayed correctly.

**Clipping:** When the 'top' or 'bottom' or both extremes of a signal are cut-off ('clipped'), e.g. because the signal cannot swing any further due to power supply limitations. An undesired property of amplifiers that are driven beyond their specs.

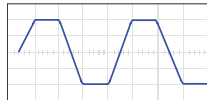

**DC coupling:** The oscilloscope displays both the AC and the DC component of a signal.

**Digital:** Digital scopes perform an analog to digital conversion on the incoming signal and handle all the calculations and displaying in the digital domain. Digital signals feature only two fixed levels, usually 0V and +5V. See also 'Analog'.

**Distortion:** Undesired alteration of a signal due to external causes such as overloaded circuits, badly designed circuits, etc...

**Noise:** Undesired random addition to a signal.

**Ripple:** Unwanted periodic variation of a DC voltage.

**Signal:** Voltage applied to the input of the oscilloscope. The subject of your measurement.

**Sine wave:** Mathematical function that represents a smooth repetitive oscillation. The waveform shown at the start of this glossary is a sine wave.

**Spikes:** Fast, short duration transients in a signal.

**AC voltage:** (AC: Alternating Current) With AC, the flow of the current periodically reverses, as opposed to DC, where the current flows in one direction. An AC source does not have a polarity.

**Bandwidth:** Usually expressed in MHz. It is the frequency at which an applied sine wave will be displayed at an amplitude of around 70% of its original amplitude. More expensive scopes feature a higher bandwidth. Rule of thumb: the bandwidth of an oscilloscope needs to be at least 5 times higher than the frequency of the signal applied to the input of the scope. The EDU09 bandwidth goes up to 200KHz.

**DC reference:** DC measurement is always performed with respect to a ground level, so we need to define this ground level. If you do not set the DC reference, the readout might not be correct. In most cases, this ground level will be the center of the screen, however this is not mandatory.

**DC voltage:** (DC: Direct Current) With DC, the current flows in a single direction, it does not reverse. A DC source has a polarity, (+) and (-).

**Input coupling:** The drawing shows typical oscilloscope input circuit. There are 3 possible settings: AC-coupling, DC coupling and GND. With AC-coupling, a capacitor is put in series with the input signal. This capacitor blocks any DC component of the signal and passes only AC. With DC coupling, the capacitor is bypassed and both the AC and DC component of the signal are passed. Low frequency signals (<20Hz) should always be displayed using DC coupling. Should AC coupling be used, the internal coupling capacitor will interfere with the signal and the displayed signal will not be correct.

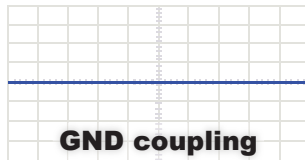
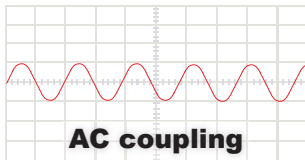
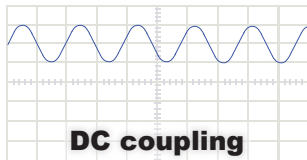

**Sample rate:** Usually expressed in samples or megasamples/second, sometimes in MHz. It is the number of times per second the digital oscilloscope 'looks' at the signal at the input. The more it 'looks', the better it is able to recreate a faithful image of the waveform on the screen. Theoretically the sample rate needs to be twice the max. frequency of the applied signal, however, for best results a sample rate of 5 times the max. frequency is recommended. The EDU09 samplerate is 1,5Ms/s or 1,5MHz.

**Sensitivity:** Indicates the smallest change of the input signal that makes the trace move up or down on the screen. Usually expressed in mV.

**Slope:** It determines where the scope will trigger. This can be on the rising or on the falling slope of the signal.



rising slope



falling slope

**Vrms:** The rms voltage of an AC source represents the required DC voltage to generate the same amount of heat in a resistor as the AC source would do. For sinusoidal signals,  $V_{rms} = V_{peak} / \sqrt{2}$





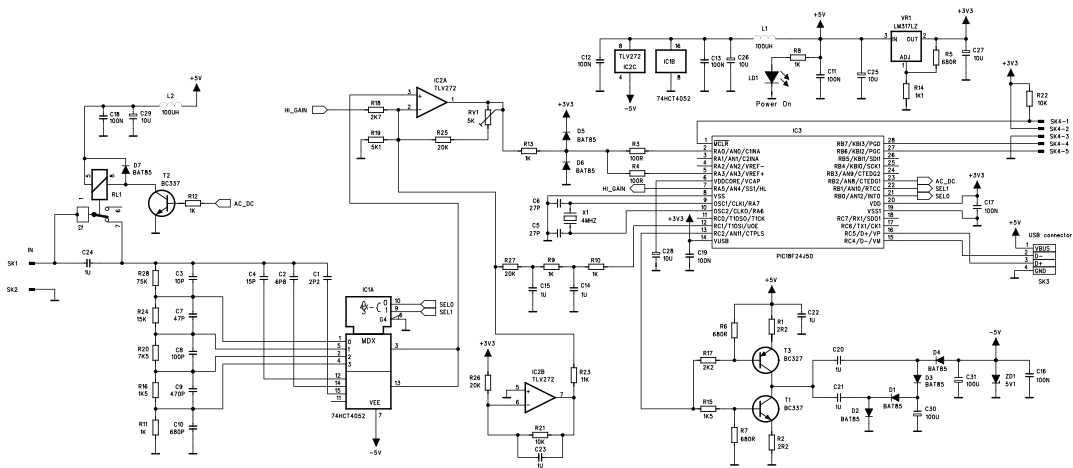

# Leds and how to use them

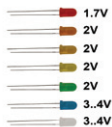

Leds feature a specific voltage drop, depending on type and colour. Check the datasheet for exact voltage drop and rated current!

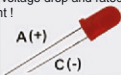

Never connect leds in parallel

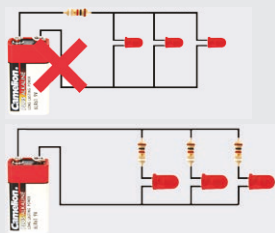

## How to Calculate the series resistor:

Example: operate a red led (1.7V) on a 9Vdc source.

Required led current for full brightness: 5mA (this can be found in the datasheet of the led)

$$\frac{\text{Supply voltage (V) - led voltage (V)}}{\text{required current (A)}} = \text{series resistance (ohms)}$$



$$\frac{9V - 1.7V}{0.005A} = 1460 \text{ ohm}$$

closest value :  
use a 1k5 resistor

Required resistor power handling=  
voltage over resistor x current passed trough resistor



$$(9V - 1.7V) \times 0.005A = 0.036W$$

a standard 1/4W resistor  
will do the job

## LEDs in series:

Example: 3 x red led (1.7V) on 9V battery

Required led current for full brightness: 5mA  
(this can be found in the datasheet of the led)

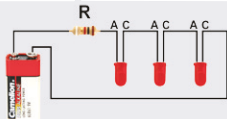

$$\frac{\text{Supply voltage (V) - (number of leds x led voltage (V))}}{\text{required current (A)}} = \text{series resistance (ohms)}$$



$$\frac{9V - (3 \times 1.7V)}{0.005A} = 780 \text{ ohm}$$

use an  
820 ohm resistor

## open collector outputs

An open collector output can be compared to a switch which switches to ground when operated

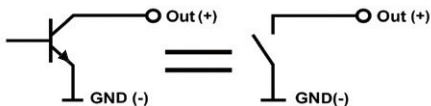

Example: How to switch an LED by means of an open collector output

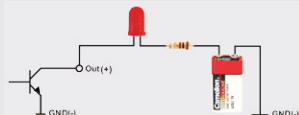

velleman®  
projects

Velleman nv, Legen Heirweg 33 - 9890 Gavere (België)



Modifications and typographical errors reserved. © - HEDU09- 2013- ED1

