

Total solder points: 205

Difficulty level: *beginner* 1 2 3 4 5 *advanced*

UNIVERSAL BATTERY CHARGER / DISCHARGER



K7300

Automatic (dis)charging of both NiCd and NiMH batteries.

Specifications:

Many battery chargers are available on the market, but few of them are universal chargers that can be used for all battery types.

Using our kit, batteries of different voltages and capacities can be charged both quickly and normally. In order to ensure that the battery is fully discharged prior to charging, an automatic discharger is also fitted.

Features:

- Charge current from 15mA to 750mA (selectable)
- Charges both of Ni/Cd and Ni/MH batteries
- Usable battery voltage: 1.2V / 2.8V / 3.6V / 4.8V / 6V / 7.2V / 8.4V / 9.6V
- Quick charge in 52 mins
- Normal charge in 14 hours
- Automatic discharge and charge cycle
- Usable mains adapter: 15VDC /800mA, type PS1508
- Dimensions: 85 x 78 mm
- Usable housing type: G311

1. Assembly (Skipping this can lead to troubles !)

Ok, so we have your attention. These hints will help you to make this project successful. Read them carefully.

1.1 Make sure you have the right tools:

- A good quality soldering iron (25-40W) with a small tip.
- Wipe it often on a wet sponge or cloth, to keep it clean; then apply solder to the tip, to give it a wet look. This is called 'tinning' and will protect the tip, and enables you to make good connections. When solder rolls off the tip, it needs cleaning.
- Thin raisin-core solder. Do not use any flux or grease.
- A diagonal cutter to trim excess wires. To avoid injury when cutting excess leads, hold the lead so they cannot fly towards the eyes.
- Needle nose pliers, for bending leads, or to hold components in place.
- Small blade and Phillips screwdrivers. A basic range is fine.

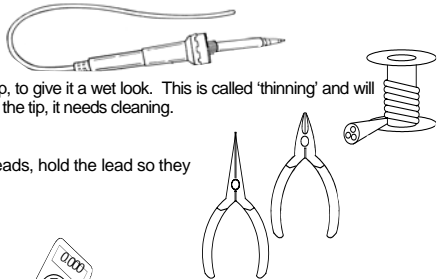

For some projects, a basic multi-meter is required, or might be handy

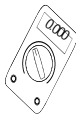

1.2 Assembly Hints :

- ⇒ Make sure the skill level matches your experience, to avoid disappointments.
- ⇒ Follow the instructions carefully. Read and understand the entire step before you perform each operation.
- ⇒ Perform the assembly in the correct order as stated in this manual
- ⇒ Position all parts on the PCB (Printed Circuit Board) as shown on the drawings.
- ⇒ Values on the circuit diagram are subject to changes.
- ⇒ Values in this assembly guide are correct*
- ⇒ Use the check-boxes to mark your progress.
- ⇒ Please read the included information on safety and customer service

* Typographical inaccuracies excluded. Always look for possible last minute manual updates, indicated as 'NOTE' on a separate leaflet.

1.3 Soldering Hints :

1- Mount the component against the PCB surface and carefully solder the leads

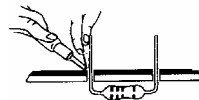

2- Make sure the solder joints are cone-shaped and shiny

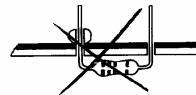
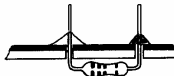

3- Trim excess leads as close as possible to the solder joint



REMOVE THEM FROM THE TAPE ONE AT A TIME !

AXIAL COMPONENTS ARE TAPED IN THE CORRECT MOUNTING SEQUENCE !

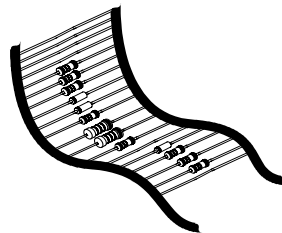

1. Jumper wires

- J (2x)

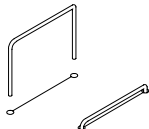

2. Diodes. Watch the polarity !

- D1 : 1N4148
- D2 : 1N4148
- D3 : 1N4148
- D4 : 1N4007
- D5 : 1N4007

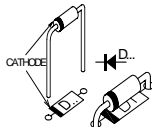

3. Zenerdiode. Watch the polarity !

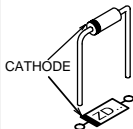

- ZD1 : 6V2
- ZD2 : 12V0

4. 1/4W Resistors

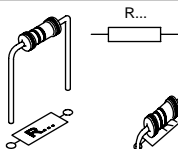

- R1 : 82 (8 - 2 - 0 - B)
- R2 : 47 (4 - 7 - 0 - B)
- R3 : 22 (2 - 2 - 0 - B)
- R4 : 18 (1 - 8 - 0 - B)
- R5 : 12 (1 - 2 - 0 - B)
- R6 : 10 (1 - 0 - 0 - B)
- R7 : 8,2 (8 - 2 - B - B)
- R8 : 6,8 (6 - 8 - B - B)
- R9 : 4,7 (4 - 7 - B - B)
- R10 : 3,3 (3 - 3 - B - B)
- R11 : 2,2 (2 - 2 - B - B)
- R12 : 3,3 (3 - 3 - B - B)
- R13 : 3,3 (3 - 3 - B - B)
- R14 : 100K (1 - 0 - 4 - B)
- R15 : 470 (4 - 7 - 1 - B)
- R16 : 2K2 (2 - 2 - 2 - B)
- R17 : 120K (1 - 2 - 4 - B)
- R18 : 15K (1 - 5 - 3 - B)

- R19 : 22K (2 - 2 - 3 - B)
- R20 : 33K (3 - 3 - 3 - B)
- R21 : 47K (4 - 7 - 3 - B)
- R22 : 82K (8 - 2 - 3 - B)
- R23 : 150K (1 - 5 - 4 - B)
- R24 : 470K (4 - 7 - 4 - B)
- R25 : 10K (1 - 0 - 3 - B)
- R26 : 10K (1 - 0 - 3 - B)
- R27 : 3K3 (3 - 3 - 2 - B)
- R28 : 10K (1 - 0 - 3 - B)
- R29 : 10K (1 - 0 - 3 - B)
- R30 : 10K (1 - 0 - 3 - B)
- R31 : 10K (1 - 0 - 3 - B)
- R32 : 10K (1 - 0 - 3 - B)
- R33 : 1K (1 - 0 - 2 - B)
- R34 : 33 (3 - 3 - 0 - B)
- R35 : 1M (1 - 0 - 5 - B)

5. 0,6W Resistor

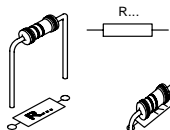

- R36 : 82 (8 - 2 - 0 - B - 9)

6. Trim potentiometer

RV1 : 220K

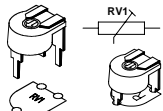

7. IC sockets. Watch the position of the notch !

IC1 : 14p

IC2 : 16p

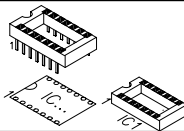

8. 1W Resistor

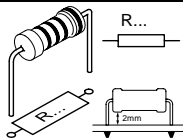

R37 : 270 (2 - 7 - 1 - B)

9. Capacitors.

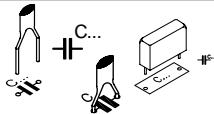

C1 : 47nF (473)

C2 : 47nF (473)

10. Transistor

T1 : BC557B

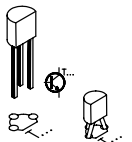

11. Reference Diode

VR1 : LM385Z-2.5

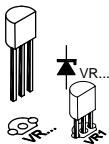

12. Pin headers

J1 : 2p

J2 : 3p

J3 : 8p

J4 : 8p

J5 : 12p

J6 : 12p

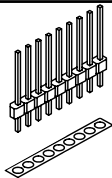

13. 10W resistors

R38 : 10

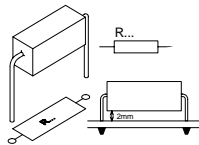

14. DC- Jack

DJ-005

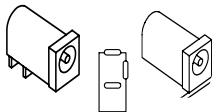

15. Electrolytic Capacitors. Watch the polarity !

- C3 : 1 μ F
- C4 : 10 μ F

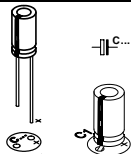

16. Power transistor

- T2 : BD237

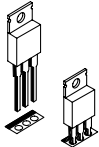

17. Terminal block

- Accu (2p)

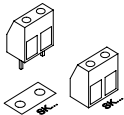

18. Push button

- SW1 : start

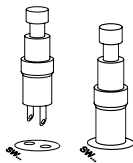

19. Electrolytic Capacitor. Watch the polarity !

- C5 : 1000 μ F

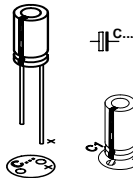

20. LEDs Watch the polarity!

- LD1 : Red
- LD2 : Green

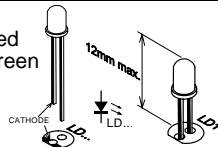

Mounting into a housing :

Mount these LEDs through the housing using the supplied holders and by extending the leads.

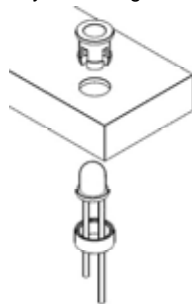

21. Power transistor

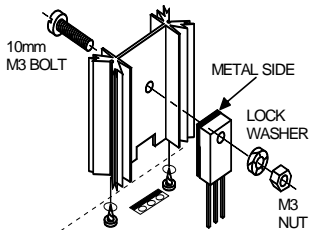

□ T3 : BD676

22. IC. Watch the position of the notch!

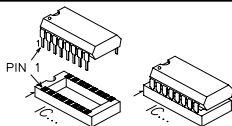

□ IC1 : CD4536

□ IC2 : LM324

23. Adjusting the built-in clock.

□ Mount a shunt over the **CAL** connection.



□ Mount a shunt over the 52 min selection (quick charge setting).

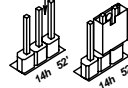

□ Mount a shunt over the 1.2V selection (charge a 1.2V battery).

□ Connect a DC mains adapter of 15V/800mA (ex. PS1508). Check that the "-" is on the outside edge of the connector.

□ Turn the trimmer, RV1, to its mid position.

□ Push the push button, SW1, the green LED should normally light up.

□ After 12 seconds, the LED should go out. If this is not the case, then adjust the trimmer. To the left reduces the time, to the right increases the time.

□ Remove the **CAL** shunt.

24. CONNECTION

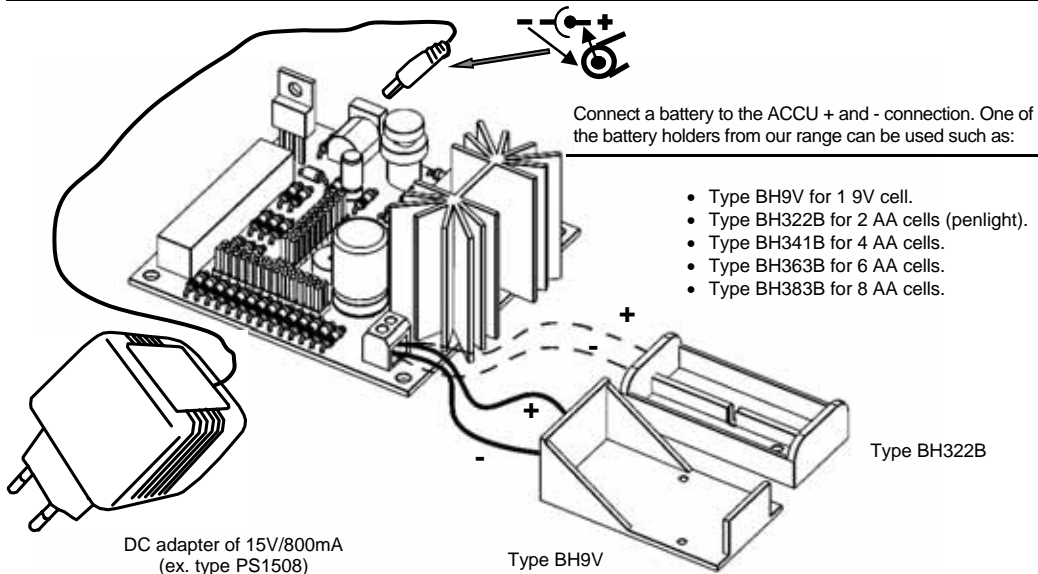

25. USE WITH NORMAL CHARGE (14h)

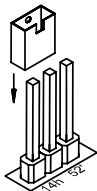

- Mount a shunt over the 14h position.

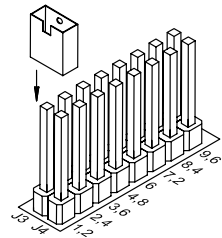

- Select the battery voltage to be connected using a shunt on the 1.2V to 9.6V connection.

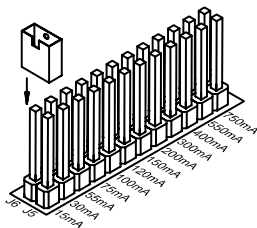

- Select the charge current with a shunt between 15mA and 750mA. The charge current of a battery can be determined by dividing the battery capacity by 10 (then select the closest to the charge current).

ex. : A battery with a capacity of 500mA/h should be charged with a current of 50mA, thus choose 55mA.

Push on the push button in order to start the cycle. If the battery is not yet completely discharged, then the red LED will light up to indicate that discharging has started. Charging will automatically start afterwards for 14h.

26. FAST CHARGE (52 mins)

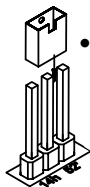

- Mount a shunt over the 52 min position.

- Select the battery voltage to be connected using a shunt on the 1.2V to 9.6V connection.

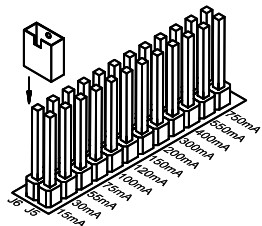

- Select the charge current with a shunt between 15mA and 750mA. The charge current of a battery can be determined by dividing the battery capacity by 10 (then select the closest to the charge current).

ex. : A battery with a capacity of 500mA/h should be charged with a current of 50mA, thus choose 55mA.

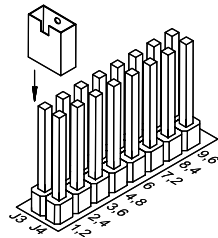

Push on the push button in order to start the cycle. If the battery is not yet completely discharged, then the red LED will light up to indicate that discharging has started. Charging will automatically start afterwards for 14h.

NOTE:

- 👉 Only use the quick charge facility in the event of an emergency, as this type of charging can reduce the battery lifetime.
- 👉 **Never** mix batteries of different capacities.
- 👉 Never select two voltages or current settings simultaneously.

27. PCB layout.

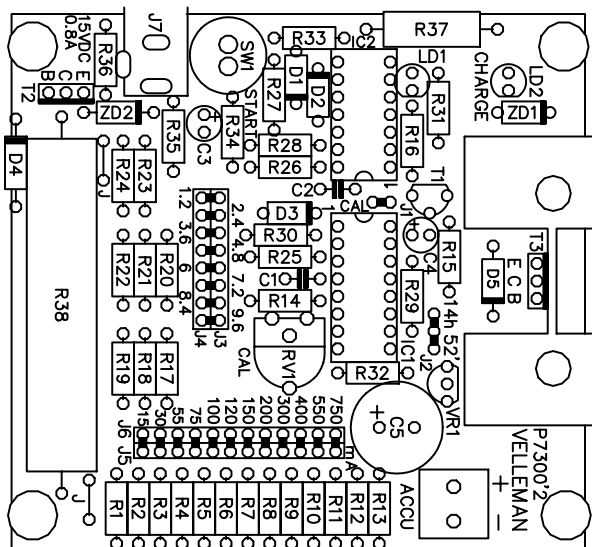



Modifications and typographical errors reserved
© Velleman Components nv.
H7300IP - 2005 - ED1

