



深圳市飞狮电池有限公司 Camelion Battery Co., Ltd.
深圳市福田区天安数码城数码时代大厦 A 座 705-708
Unit 705-708, Cyber Times Tower A, Tian'an Cyber Park, Shenzhen, China 518041
Tel: 0086 755 8361 8088 Fax: 0086 755 8347 5720
www.camelionbattery.com

产 品 规 格 书

Product Specification

客户名称/Customer : _____

产品型号/Model : CAMELION 28AA600mAh×3

制作/Prepared By : _____

审核/Checked By : _____

批准/Approved By : _____

日期/Date : _____

客户确认/Confirmed By : _____

1. SCOPE / 说明

This specification is applied to the reference battery in this Specification and manufactured by CAMELION BATTERY CO., LTD.

本说明书用于本书中涉及的深圳市飞狮电池有限公司的镍氢电池产品。

2. BATTERY MODEL / 电池型号:

CAMELION 28AA600mAh×3

3. EXTERNAL APPEARANCE/外观

The cell / battery shall be free from cracks, scars, breakage, rust, discoloration, leakage and deformation.

电池应无裂痕、划迹、灰尘、变色、漏液及变形等等。

4.RATINGS / 额定性能

Item/项目	Unit/单位	Specification/指标	Conditions/条件
Nominal Voltage/标称电压	V	3.6	Pack unit / 组合电池
Nominal Capacity/标称容量	mAh	630	Standard charge /discharge 标准充放电:
Minimum Capacity/最小容量	mAh	600	
Standard charge/标准充电	mA	60 (0.1C)	Ta=20±5°C
	hour	16	
Quick Charge/快充	mA	300 (0.5C)	Ambient Temperature/ 环境 温度: Ta=10-40°C, -ΔV=5mV/cell
	hour	2.4	
Rapid Charge/急充	mA	600 (1C)	
	hour	1.2	
Trickle charge/涓流充电	mA	0.02C-0.05C	Ta=0-40°C
Standard discharge 标准放电	mA	120 (0.2C)	Ta=20±5°C Humidity / 湿度: 65±20% Discharge by 0.2C to 1.0V/cell ; 0.2C 放电至 1.0V/支;
Maximum Discharge Current 最大放电电流	mA	600 (1C)	Ta=-20~60°C; 1.0V/ cell cut off/截止电压 1.0V/支
Storage temperature 存储温度	°C	-20°C~25 within 1 year -20°C~35 within 6 month -20°C~45 within 1 month -20°C~55 within 1 week	Relative humidity: 65±20% 相对湿度: 65±20%

Weight/重量	g	Approx38	Pack unit / 组合电池
-----------	---	----------	------------------

5. PERFORMANCE/性能

Unless otherwise stated, tests should be done within one month of delivery under the following conditions: /除特别申明外, 应在发货后一个月内按以下条件测试:

Ambient Temperature/环境温度: 20±5°C

Relative Humidity/相对湿度: 65±20%RH

Notes/注: Standard Charge/Discharge Condition/标准充/放电条件

Charge/充电: 60mA (0.1C) ×16 hrs

Discharge/放电: 120mA(0.2C) to 3.0V/ Pack

检测项目	单位	标准	条件	备注
Open circuit voltage 开路电压	V	≥3.75	Within 1 hr after standard charge/标准充电后搁置 1 小时	Pack unit /组合电池
Internal impedance 内阻	mΩ	≤150	Within 1 hr after standard charge/标准充电后搁置 1 小时	Pack unit /组合电池
Low Rate Discharge 低倍率放电 (0.2C)	Minute/分钟	≥300	Standard Charge , 1hr rest before discharge 标准充电后搁置 1 小时再放电	Allow to 3 cycle 允许循环三次
High Rate Discharge 高倍率放电 (0.5C)	Minute/分钟	≥112	Standard Charge , 1hr rest before discharge 标准充电后搁置 1 小时再放电	Allow to 3 cycle 允许循环三次
High Rate Discharge 高倍率放电 (1C)	Minute/分钟	≥51	Standard Charge , 1hr rest before discharge 标准充电后搁置 1 小时再放电	Allow to 3 cycle 允许循环三次
Overcharge 过充	N/A	No leakage nor Deformation 无漏液或变形	0.1C charge for 48 hrs 0.1 C 充 48 小时	
Charge retention 荷电保持能力	mAh	≥360 (60%)	Standard charge Storage: 28 days at Ambient Temperature or 7 days at 45°C Standard discharge 标准充电, 环境温度下贮存 28 天或 45°C 贮存 7 天, 标准放电	
IEC Cycles Life Test IEC 循环寿命测试	Cycle/周	≥500	IEC 61951-2 (2011) /7.5.1.2	(see note 1)见备注 1

续上表:

<p>Short Circuit 短路测试</p>	<p>N/A</p>	<p>Leakage&deformation may occur, but no explosion is allowed 容许漏液、变形, 但不许爆炸</p>	<p>After standard charge., short circuit the cell at 20+/-5°C until the cell temperature returns to ambient temperature. (The resistance of the inter- connecting circuitry shall not exceed 0.1Ω.) 标准充电后, 20±5°C下将电池短路直到电池温度降为环境温度, 用于短路的连接物电阻不能超过 0.1Ω</p>	<p>Ta=20±5°C</p>
<p>Vibration Resistance/振荡</p>	<p>N/A</p>	<p>Change of voltage: < 0.02V/cell change of internal < 5mΩ/cell 电压变化: < 0.02V/支 内阻变化: < 5mΩ/支</p>	<p>Charge at 0.1C for 16hrs and then leave for 24hrs check battery before after vibration Amplitude: 1.5mm Vibration:3000CPM (any direction for 60mins)/0.1C 充电 16 小时, 搁置 24 小时后振荡, 振荡前后检测电池, 振荡条件: 振幅: 1.5mm 频率: 3000CPM (任意方向振荡 60min)</p>	
<p>Impact Resistance / 跌落</p>	<p>N/A</p>	<p>Change of voltage: < 0.02V/cell change of internal < 5mΩ/cell 电压变化: < 0.02V/支 内阻变化: < 5mΩ/支</p>	<p>Charge at 0.1C for 16hrs and then leave for 24hrs check battery before/ after drop Height: 100cm Thickness of the wooden board: 30mm Direction is not specified Test for 3 times 0.1C 充电 16 小时, 搁置 24 小时, 从 100cm 高处跌至厚 30mm 木制物体上, 任意方向跌落三次</p>	
<p>Leakage 漏液测试</p>		<p>No leakage nor deformation 无漏液或变形</p>	<p>Standard charge stand for 14 days 标准充电后存放 14 天检查</p>	
<p>Safety 安全性</p>		<p>无破裂或爆炸, 但允许漏液和变形. No disrupt or burst, explosion, but leakage of electrolyte and deformation are acceptable</p>	<p>电池在环境温度 20±5°C下以恒流 0.2ItA 强制放电至 0.0V,然后将电流提高到 1.0ItA,并在相同环境温度下继续强制放电 60 分钟. The battery shall undergo a forced discharge in an ambient temperature of 20±5°C,at a constant current of 0.2ItA,to a final voltage of 0V.the current shall then bi increased to 1.0ItA and the fored discharge continued in the same ambient temperature of 20±5°C ,for 60 min.</p>	<p>Ta=20±5°C</p>

Notes/备注：

1、Approximate charge time from discharged rate, for reference only IEC 61951-2 (2011) 7.5.1.2

Cycle Life Test

充放电时间仅供参考，IEC 61951-2 (2011) /7.5.1.2 循环寿命测试

Cycle No. 循环次数	Charge 充电	Rest 搁置	Discharge 放电
1	0.1C, 16h	None/无	0.25 C, 2h 20min
2—48	0.25 C, 3h 10min	None/无	0.25 C, 2h 20min
49	0.25 C, 3h 10min	None/无	0.25 C to 1.0V/cell
50	0.1 C, 16h	1h-4h	0.2 C to 1.0V/cell

Cycle 1 to 50 shall be repeated until the discharges duration on any 50th cycle becomes less than 3hrs/循环至任一第 50 次放电时间不足 3 小时为止。

2、EXTERNAL APPEARANCE/外观

The cell / battery shall be free from cracks, scars, breakage, rust, discoloration, leakage and deformation.
电池应无裂痕、划迹、灰尘、变色、漏液及变形等等。

3、WARRANTY /保质期

One year limited warranty against workmanship and material defects.
因加工制造及材料造成的缺陷，有效保质期一年。

4、ELECTRICITY RETAINS/带电量

Normal conditions with electricity retain 50%, if have special demands, confirm after negotiate
正常情况下，电池出厂前带电 50%，如有特殊要求，需提出后确认。

5、WARNING/警告

5.1 Do not reverse charge batteries

不允许反向充电，应将电池按极性准确连接，不可反接。

5.2 Do not short circuit batteries, permanent damage to batteries may result

不允许短路，否则将导致永久性损坏。

5.3 Do not subject batteries to adverse condition such as extreme temperature, deep cycling and excessive.

电池不能在极限条件下使用，如：极限温度、深度循环、极度过充电及过放电。

5.4 Store batteries in a cool dry place. Always discharge batteries before bulk storage or shipment.

请将电池贮存于阴凉干燥的地方，若大量电池贮存或船运时电池须先放完电。

5.5 Do not solder directly to cells or batterie

请勿直接对电池焊锡。

5.6 If find any noise, excessive temperature or leakage from a battery, please stop its use.

若电池出现噪音、高温、漏液等异常情况，请立即停止使用。

5.7 Do not incinerate or mutilates batteries, may burst or release toxic material.

请勿投入火中或试图拆开，电池可能会燃烧或产生有害的物质。

5.8 Do not mix new batteries in use with semi-used batteries, over-discharge may occur.

不允许将旧电池或使用一半的电池与新电池混合使用，否则会产生过放电。

5. 9 Do not remove the outer sleeve from a battery pack nor cut into its housing
不可切开外壳和去掉电池的外套管。
5. 10 Never put a battery into water or seawater.
不允许将电池放入水中。

6、CAUTION/注意

6. 1 Batteries should be charged prior to use.
电池使用前应充好电。
6. 2 For charging methods please referred to our technical handbook.
充电方法按我司的技术规格书。
6. 3 Use the correct charger for Ni-MH batteries.
使用相应的充电器充电。
6. 4 Avoid batteries being used in an airtight compartment. Ventilation should be provided inside the battery compartment, otherwise batteries may generate hydrogen gas, which could cause an explosion if exposed to an ignition source.
电池应避免密封使用，应提供相应的通风装置，否则电池可能会产生氢气，在有点火源的情况下会引起爆炸。
6. 5 Do not attempt to take batteries apart or subject them to pressure or impact. Heat may be generated or fire may result. The alkaline electrolyte is harmful to eyes and skin, and it may damage clothing upon contact.
不要企图将电池组分离或承受挤压和碰撞，可能会导致电池发热、冒火，溅出的碱性电解液将损害皮肤和眼睛也会腐蚀衣服。
6. 6 Keep away from children. If swallowed, contact a physician at once.
应将电池远离小孩，若被吞食，需立即联系医生处理。
6. 7 When using a new battery for the first time or after long term storage, please fully charge the battery before use.
当电池不使用时，应将之从设备上取下。
6. 8 When using a new battery in use with semi-used batteries, over-discharge may occur.
当第一次使用新电池或长期贮存后使用时，使用前需充满电。
6. 9 When the battery is hot, please do not touch it and handle it, until it has cooled down.
当电池发烫时，请勿碰触，直到它冷却下来。
6. 10 When find battery power down during use, please switch off the device to avoid over discharge./当电池使用时发现能量下降时应关掉设备，以避免过放电。
6. 11 Unplug a battery by holding the connector itself and not by pulling at its cord.
拔出电池组时，应握着电池组端子而不能握着线。
6. 12 After use, if the battery is hot. Before recharging it, allow it to cool in a well-ventilated place out of direct sunlight.
电池使用后，若电池较热，在再次充电前可将之放于通风无阳光直射的地方冷却。

7、STORAGE/贮存

7. 1 In order to ensure the battery to maintain the capacity level, we suggest Ni-MH battery and battery pack should be stored under the condition of the -20 ~ 35 °C, low humidity, no corrosive gases.
为保证电池维持容量水平，建议镍氢电池及电池组在-20~35℃、低湿度、无腐蚀性气体条件下贮存。
7. 2 Ni-MH battery to avoid the high temperature or high humidity storage, otherwise it would

lead to the battery leakage, rust, and the lower capacity.

镍氢电池避免在高温度或较高湿度下贮存，否则将导致电池漏液、生锈，以及容量较低。

- 7.3 **The long-term storage may lead to NIMH batteries and battery packs to reduce the capacity and need 1-3 charge / discharge cycles to reach the maximum discharge capacity.**

长期存放将可能导致镍氢电池及电池组容量降低，并需要 1-3 个充电/放电循环后才能达到最高放电容量。

- 7.4 **Three months after placing the battery need to be charge/discharge for one cycle./**

电池放置三个月后需要循环一次。

Type/型号: Rechargeable Nickel Metal Hydride Cylindrical Cell/可充镍氢圆柱形电池

Specification of single cell/单支电池规格

Nominal Voltage/标称电压_		1.2V
Internal Resistance/内阻		40mΩ
Capacity/容量	Nominal/标称容量	630mAh
	Minimum 最小	600mAh
Weight/重量		About 12.0g
Charge./充电	Standard/标准	0.1C
	Fast/快速	0.5C~1C
Temperature Recommended/建议温度 (°C)	Standard charge 标充	20±5°C
	Fast charge 快充	10~40°C
	Discharge 放电	-20~60°C
	Storage 储存	-20~35°C
Dimensions with tube/带套管尺寸	A: Diameter/直径	14.5 (+0/-0.7) mm
	B: Height/高	28.5(+0/-1.0) mm
	C: Top diameter/帽径	8.0mm
	D: Top height/帽高	0.6mm
Continuous Overcharge 过充	0.1C for 48 hrs/0.1C 充 48 小时	

Charge curve/充电曲线

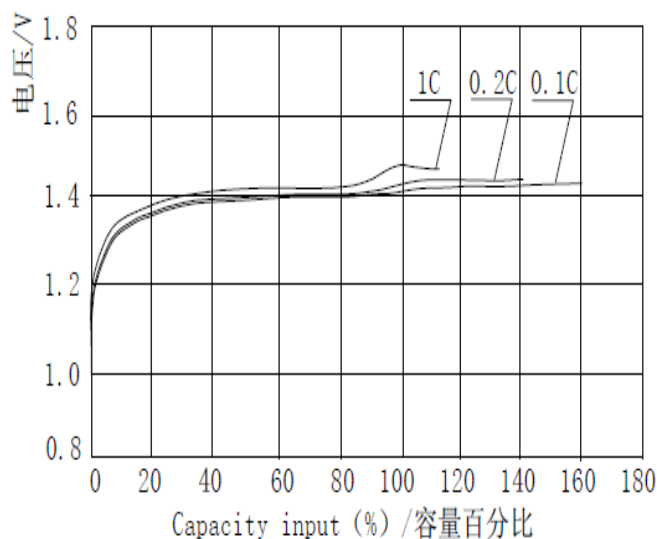

Low rate discharge/低倍率放电

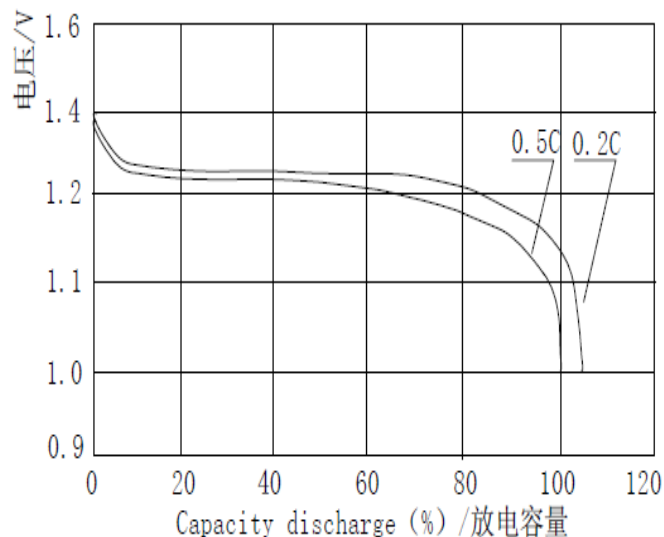

High rate discharge/高倍率放电

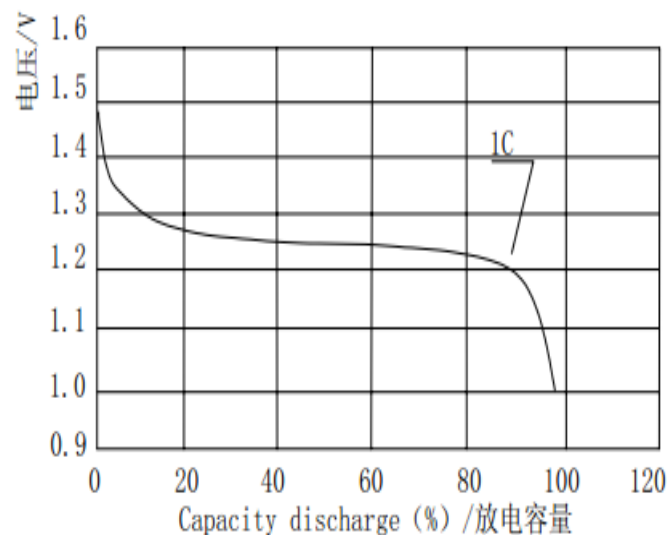

Drawing/示意图

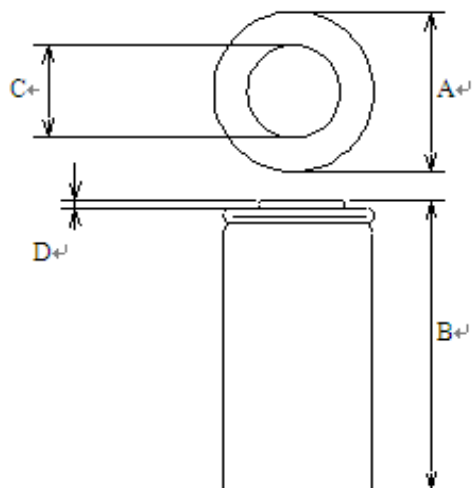

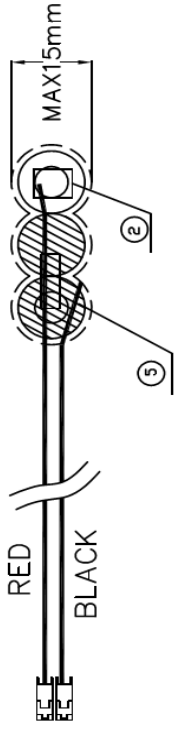

Vertical View

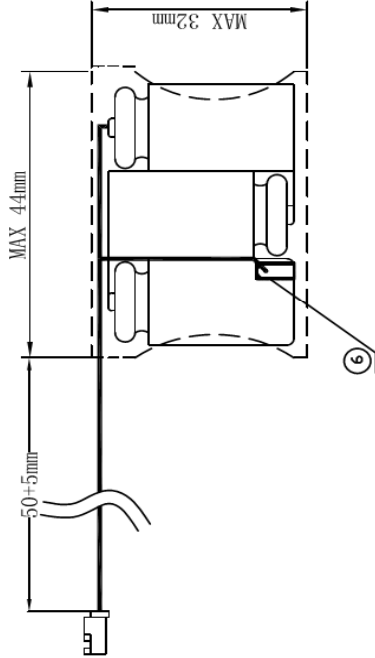

Front View

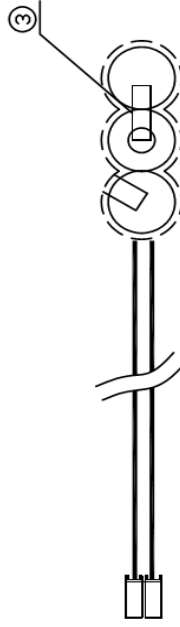

Bottom View

Camelion®	Prepared by	Signature	Date
	Checked by		
	Approved by		
ITEM MODEL:	EH-28AA600C3BMU		

Doc.No.	ECD-002
Draw.No.	
Edition	A

No.	Name	QTY	Description	Remarks
8	Insulation tube	1	16*15mm	⑥
7	Insulation tube	1	WIDE:12mm	⑤
6	Gasket	3	AA white	
5	PVC tube	3	22.8mm green	
4	PVC tube	1	44mm green	④
3	Ni Connector	2	0.1*4*18	③
2	Tab terminal	1/1	0.1*4*9/4*18	②
1	PLUG	1	Univels UL1007 AWG24 R=B=89mm	①